

**Whitco**<sup>®</sup>  
SECURING YOUR HOME™

# Sliding Security

Door Hardware



# Sliding Security Screen Door Hardware

## Leichhardt

### Application/Description

Single & Multi point mortice sliding security door lock available in Ultra Strength & Standard versions

### Features and Specifications

Suits either Left or Right hand closing sliding doors

Parrot beak deadlock

Key deadlock from both sides

Self latching

Inside snib

Key overrides snib operation

Accepts Whitco Euro profile lazy cam cylinder locks

Can only be key locked or snibbed when fully latched with striker

Optional Multi Point kits available for 2 and 3 point applications

*Ultra Strength* version includes Stainless Steel parrot beak and striker

*Ultra Strength* version recommended for use on security screen doors to assist in compliance to Australian Standards

Standard version available in Display and Trade pack

Single point version available

*Ultra Strength* version & Multi point kits versions available in Trade pack

Australian made with imported cylinder

Zinc diecast furniture and locking mechanism

Steel zinc plated cover plate

### Keying

Use with Whitco Euro profile lazy cam cylinder locks

2 x 5 pin cylinder lock

2 x 10 disc cylinder lock

### Non Standard Finishes

Other polyester powder coat finishes available on application



Security Screen



Flyscreen

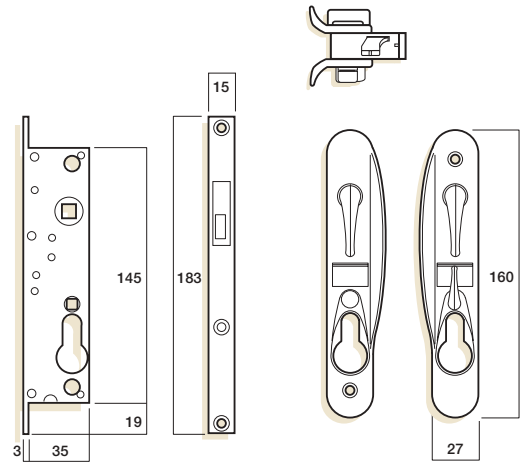

Cylinder locking

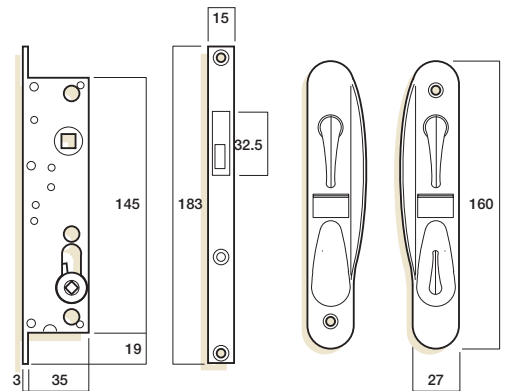

Snib locking

## Ordering

•• Denotes finish. See price list for available pack / finish combinations

### Display Pack

Standard striker, furniture no cylinder centre lock, screws

W8679••

### Trade Pack

#### Standard

Centre lock furniture, Standard parrot beak bolt and strike, inside snib, no cylinder – Single point lock Mechanism, suits standard 20 mm doors

W8667••

Furniture with extended lever and snib – Single point lock mechanism, suits 30 mm door thickness

W8669••

Furniture, standard Parrot beak bolt & strike, inside snib, no cylinder – to suit multi point kits

W8653••

Furniture, snib inside only - mechanism, Standard strike, No cylinder

(right hand)

W866417

(left hand)

W866517

Dummy Pull set – Internal and external pull

W866617

#### Ultra Strength

Furniture, Stainless Steel Ultra Strength parrot beak & strike, inside snib, no cylinder

W8643••

# Sliding Security Door Hardware

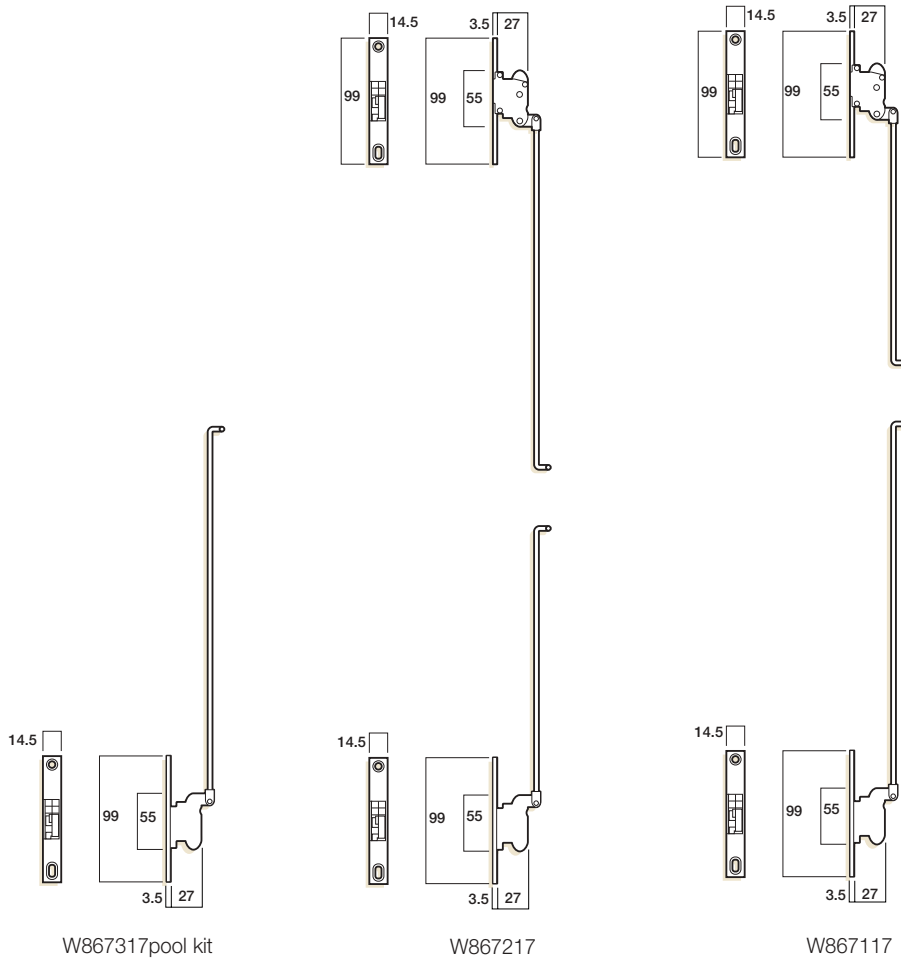

W867317pool kit

W867217

W867117

## Accessories

### Standard centre lock Keeper

Zinc diecast, Zinc plated W868101

### Wideline Keeper

suits Wideline section / Zinc diecast, Zinc plated W866801

### Multi point kit – 3 point

3 point lock kit including rods, two auxiliary locks, keeper & screws, suits door height up to 2040 mm

Above centre line kit W8671 ●●

Below centre line kit W8672 ●●









### Multi point kit – 2 point

2 point lock kit including rod, auxiliary lock, Keeper and screws, 1 mm W8673 ●●

Suitable for doors accessing pool area. Where centre lock is at least 1,500 mm above Floor

## Standard Finishes

●● Denotes finish. Available in the following polyester powder coat finishes

 Silver 11	 Brown 13	 White 16	 Black 17
 Gold Spangle 18	 Primrose 19	 Doeskin 23	 Magnolia 24
 Stone Beige 28			

## Sliding Security Door Hardware

### Cylinder – Euro profile lazy cam

#### Application/Description

Cylinder to suit Whitco Leichhardt, Tasman & Tasman Escape security screen door locks

#### Features and Specifications

Available in Bright Chrome  
Double cylinder, C4 key profile  
Brass and zinc die cast construction  
Display and Trade packs available  
Made to Whitco specifications

#### Keying

Two versions available:  
2 x 5 pin, C4 key profile cylinder lock, can be keyed alike to other Whitco 5 pin C4 cylinder locks  
2 x 10 disc, profile cylinder locks  
Two Whitco chrome plated brass keys included

#### Non Standard Finishes

Other finishes are not available

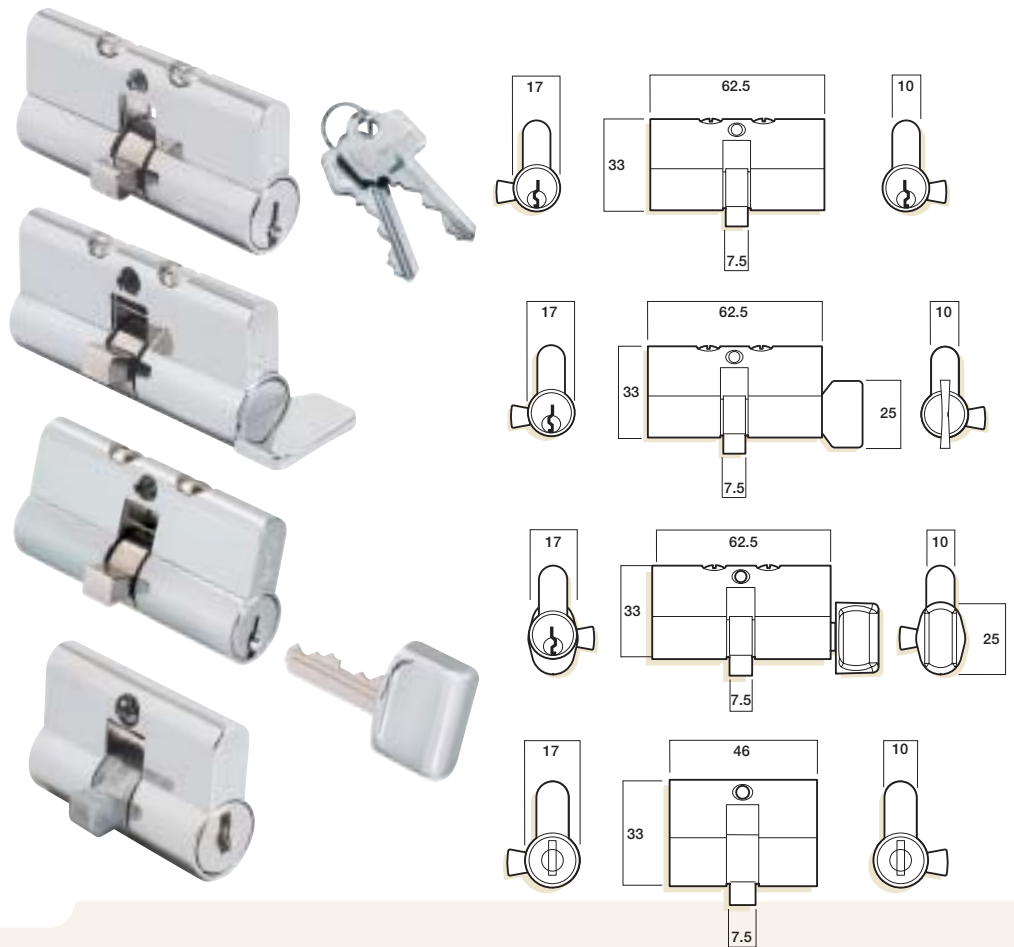

#### Standard Finishes

Bright Chrome 00

#### Ordering

Bright Chrome unless otherwise stated

##### Display

###### Double Cylinder

2 x 5 pin	W840700
2 x 10 disc	W840800

##### Trade Packs

###### 2 x 5 pin / Double Cylinder

Random keyed	
2 Keyed Alike	W842200
3 Keyed Alike	W842300
4 Keyed Alike	W842400
10 Keyed Alike	W842500
10 Keyed Alike-Gold Plated	W842502
20 Keyed Alike	W842600
50 Keyed Alike	W842800

###### Turnknob & 5 Pin

Random Keyed

Turnknob & 5 Pin / Right Hand W845500

Random Keyed Turnknob & 5 Pin / Left Hand W845600

2 Keyed Alike Turnknob & 5 Pin / Right Hand W845700

2 Keyed Alike / Turnknob & 5 Pin / Left Hand W845800

Random Keyed / Non-handed Turnknob & 5 Pin W841500

2 Keyed Alike / Non-handed Turnknob and 5 Pin W841600

###### 2 x 10 Disc / Double Cylinder

Single random keyed W841400

2 Keyed Alike W843200

3 Keyed Alike W843300

4 Keyed Alike W843400

10 Keyed Alike W843500

20 Keyed Alike W843600

#### Use In

Whitco Leichhardt Sliding Security Screen Door Lock  
Whitco Tasman Hinged Security Screen Door Lock

Whitco Tasman Escape Hinged Security Screen Door Lock  
Whitco Triple Lock Hinged Security Screen Door Lock

# Sliding Security Door Hardware

## Bass

### Application/Description

Sliding screen door latch

### Features and Specifications

- Suits either Left or Right hand closing sliding doors
- Parrot beak latch
- Surface mounted
- Can be latched from inside or outside
- Slim low stand-off design
- Zinc die cast handle
- Galvanised steel lock plate and strike
- Available without lugs

Trade pack available  
Australian made

### Keying

Not keyed

### Non Standard Finishes

Other polyester powder coat finishes available on application



Aluminium



Timber



Flyscreen

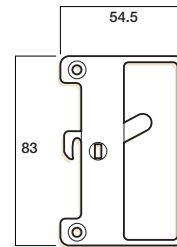

## Standard Finishes

Available in the following polyester powder coat finishes



Black 17

## Ordering

See price list for available pack / finish combinations

### Trade Pack

Standard strike, standard body, no finger plate and no outer pull	W8213●●
Jason strike, no lugs body, outer pull and long snib	W8235●●
Cropped strike, standard body, finger plate and no outer pull	W8234●●

# Sliding Security Door Hardware

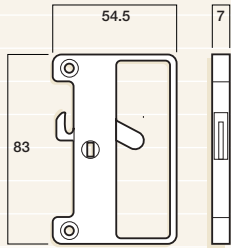

Standard Body W8215

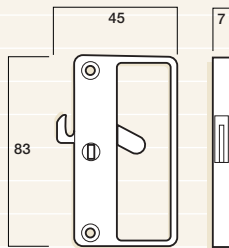

No lug body W8215

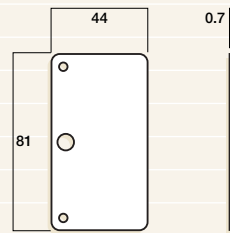

No lug Finger plate W8220

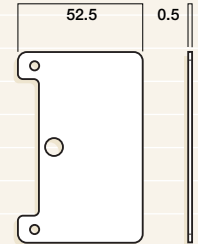

Finger Plate W8223

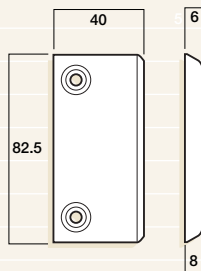

Outer pull with hole

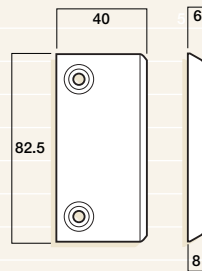

No hole outer pull W8227

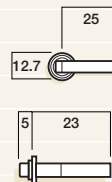

Short Snib W8221

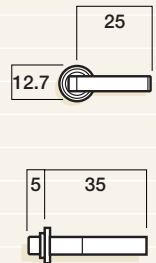

Long snib W8222  
Suit 30 mm door thickness

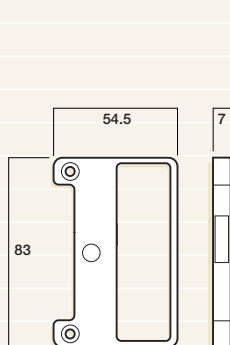

Dummy body W8216

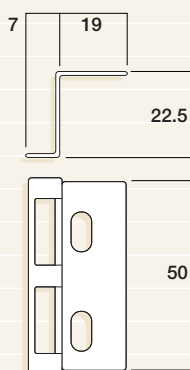

Standard strike

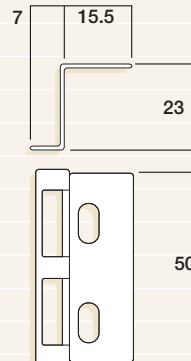

Cropped strike W8234

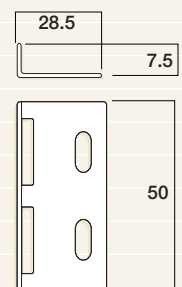

Bi-part strike W8224

## Sliding Security Door Hardware

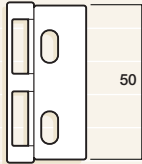
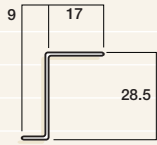

Stegbar strike W822617

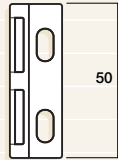
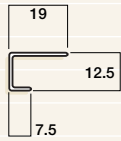

Jason strike W822517

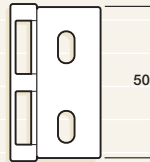
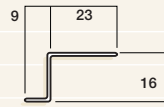

Vincent strike

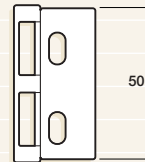
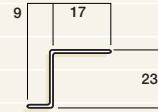

Comalco strike W823617

# Sliding Security Door Hardware

## Sliding Door Closers

### Application/Description

Sliding security door closer

### Features and Specifications

Smooth pneumatic operation  
 Suits either Left or Right hand closing sliding doors  
 Adjustable closing speed  
 Surface mounted  
 Tough UV resistant ABS polymer construction  
 Suits minimum 900 mm door opening

Display pack available  
 Australian made

### Keying

Not keyed

### Non Standard Finishes

Not available in other finishes

### Accessories

No accessories are available



Aluminium



Security Screen



Flyscreen

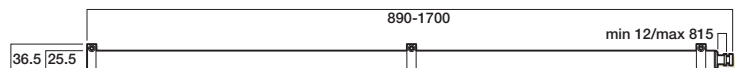

## Standard Finishes

Available in black 17

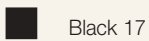

Black 17

## Ordering

### Display Pack

W812117



# Sliding Security Door Hardware

## Sliding Screen Door Rollers

### Application/Description

Sliding Screen and Sliding Security Screen Door

### Features and Specifications

- 'Speed Fit' applicator lugs
- Offset wheel function\*
- Fully adjustable under load
- Spring Loaded
- Large 11mm adjustment
- Adjustable from both sides
- Quick insert rim
- Inner case will not dislodge
- A + B identification for offset applications
- Retrofits existing rollers
- Suits both top and bottom rails

Available in Trade pack  
Made to Whitco specifications

### Keying

Not keyed

### Non Standard Finishes

Not available in other finishes

### Accessories

No accessories are available

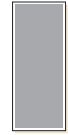
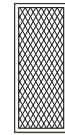

Security Screen Flyscreen

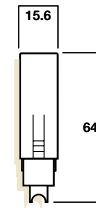
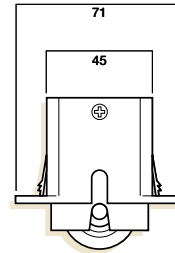
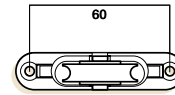

### \*Offset Wheel Function

To offset the door in order to reduce scraping or clashing with another door panel simply remove only the roller from the unit, rotate it 180 degrees, then replace it back into the unit. This will offset the panel or door 1mm.

Note. If the offset is incorrectly placed remove the entire unit, rotate it 180 degrees and then replace the entire unit.

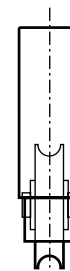

centred

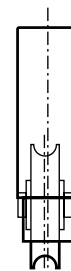

1mm off centre

## Standard Finishes

Available in black 17

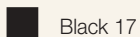

Black 17

## Ordering

### Trade Pack

W862600 Spring Loaded



Visit us at: [www.whitco.com.au](http://www.whitco.com.au)

## Sales Offices & Authorised Agents

### Victoria – Head Office

50 Edward Street  
Oakleigh VIC 3166  
Telephone (03) 8574 3888  
Facsimile (03) 8574 3788

### Queensland South

450 Sherwood Road  
Sherwood QLD 4075  
Telephone (07) 3373 5200  
Facsimile (07) 3373 5256

### Queensland North

Ralph Buck Agencies  
15 Mackley Street  
Garbutt QLD 4814  
Telephone (07) 4779 0177  
Facsimile (07) 4775 1480

### New South Wales – Commercial

Unit 1/16 Atkinson Road  
Taren Point NSW 2229  
Telephone (02) 8543 3700  
Facsimile (02) 9531 7944

### New South Wales – Residential

Unit 5/30 Foundry Road  
Seven Hills NSW 2147  
Telephone (02) 9620 9111  
Facsimile (02) 9620 9055

### South Australia

182 Magill Road  
Norwood SA 5067  
Telephone (08) 8364 1930  
Facsimile (08) 8364 1931

### Western Australia

45 Gladstone Street  
East Perth WA 6004  
Telephone (08) 9227 9588  
Facsimile (08) 9227 8913

### Tasmania

23 Antill Street  
South Hobart TAS 7000  
Telephone (03) 6223 5404  
Facsimile (03) 6224 0435

### Auckland

9B Mahunga Drive  
Mangere Bridge  
Auckland New Zealand  
Telephone (09) 634 5590  
Facsimile (09) 634 5589

### Christchurch

Unit 5, 8 Venture Place  
Christchurch New Zealand  
Telephone (03) 379 4810  
Facsimile (03) 379 4819

### Wellington

47 Kenepuru Drive  
Porirua  
Wellington New Zealand  
Telephone (04) 237 0808  
Facsimile (04) 237 0060

## Manufacturing Plants

### New Zealand

5 Armstrong Road  
North Harbour Industrial Estate  
Albany, Auckland NZ  
Telephone +64 (0)9 6224 804  
Facsimile +64 (0)9 6224 802

## Export Department

50 Edward Street  
Oakleigh VIC 3166  
Telephone +61 (0)3 8574 3888  
Facsimile +61 (0)3 8574 3789

## Asian Offices

### Assa Abloy – Malaysia

### Assa Abloy – Singapore

### Assa Abloy – Thailand

### Assa Abloy – Hong Kong

### Assa Abloy – Shanghai

### Assa Abloy – Beijing

Contact the Export Department,  
Australia for details.

## Worldwide Distributors

Contact the Export Department,  
Australia for details.



### Victoria

50 Edward Street  
Oakleigh VIC 3166  
Telephone (03) 8574 3888  
Facsimile (03) 8574 3788



### Queensland

450 Sherwood Road  
Sherwood QLD 4075  
Telephone (07) 3373 5200  
Facsimile (07) 3373 5256



## Whitco Warranty

Whitco Pty Ltd ("Whitco") warrants its products to be free from defects in material and workmanship for a period of seven years from the date of purchase by the retail customer.

With exception, Whitco warrants all door screen & window screen products for a period of twelve months, excluding key locks and hinges therein which have a warranty of seven years from the date of purchase by the retail customer.

This warranty is limited at Whitco's option to the replacement of any product proven to be faulty in manufacture or materials, with the same or equivalent product free of charge. Labour charges, transportation and other costs associated with the replacement or re-installation of the parts or products are excluded from this warranty and will not be paid by Whitco.

Whitco assumes no liability under the warranty for the following:

- Misuse, abuse, accidental or intentional damage,
- Improper maintenance and installation,
- Unauthorised repair or modifications,
- Use contrary to instructions furnished by Whitco,

- Use of replacement parts other than authorised parts,
- Corrosion related damages when used in a corrosive environment,
- Tarnish or excessive wear on soft finishes such as Bronze, Brass and other Antique finishes is not covered by this warranty as deterioration is possible under some climatic conditions, frequency of use or other factors,
- Whilst Gold, Chrome and powder coated finishes are warranted against tarnish, they shall not be covered for deterioration caused by damage to the protective layer,
- Deterioration in colour and performance of polymer materials,
- Malfunction or failure of the product due to the use of non-genuine Whitco parts and cylinders.

To the extent permitted by law, Whitco shall not be liable to the purchaser, common user or any other person for any incidental or consequential damages arising howsoever and including but not limited to damages from any defect, malfunction or failure of any product or component.

To the extent permitted by law, this warranty is the exclusive warranty granted by Whitco and is in lieu of all other express or implied warranties. There are no implied warranties as to merchantability, quality or fitness for a particular purpose. In all other respects the Standard Terms and Conditions of Whitco apply.

